

Technical Specifications

Nominal Voltage	12 V	
Nominal Capacity	18.0 Ah (20 Hr Rate)	
Chemistry	Lead Acid - AGM	

Physical Specifications

Length:	181 mm	7.13 in.
Width:	76 mm	2.99 in.
Height:	167 mm	6.57 in.
Height w/ Terminal:	167 mm	6.57 in.
Weight	5.60 Kg	12.32 lbs
Terminal Type	Flag	

Case Material	Black ABS	
---------------	-----------	--

Charging Specifications

	Bloc	Per Cell
Charge Voltage	Float 13.5~13.8	2.25~2.30
(constant)	Cycle 14.4~14.7	2.40~2.45
Max. Charge Current	5.1 A	
Approx Final Charge Current (2.25 volts/cell Float)	0.03 A	
Approx Final Charge Current (2.45 volts/cell Cycle)	0.15 A	

Due to changes in the manufacturing processes, specifications are subject to change without notice

Operating Temperature Specifications

Charge Temp Range	0°C~40°C(32°F~104°F)
Discharge Temp Range	-20°C~50°C(-4°F~122°F)
Storage Temp Range	-20°C~40°C(-4°F~104°F)

Capacity Specifications

Cut-off Voltage	20 Hr Rate (0.90A)	18.0 Ah
1.75 volts/cell @ 25°C	10 Hr Rate (1.60A)	16.0 Ah
1.70 volts/cell @ 25°C	5 Hr Rate (2.90A)	14.5 Ah
1.55 volts/cell @ 25°C	1 Hr Rate (9.80A)	9.8 Ah
Discharge Current	(5 seconds maximum)	250 A
Discharge Current	(maximum continuous)	80 A
Self Discharge (to 80% capacity)	9 months @ 21°C	
Internal Resistance	12~15 mΩ	

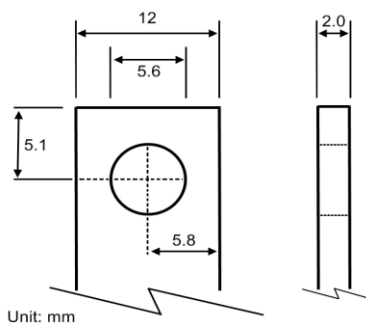
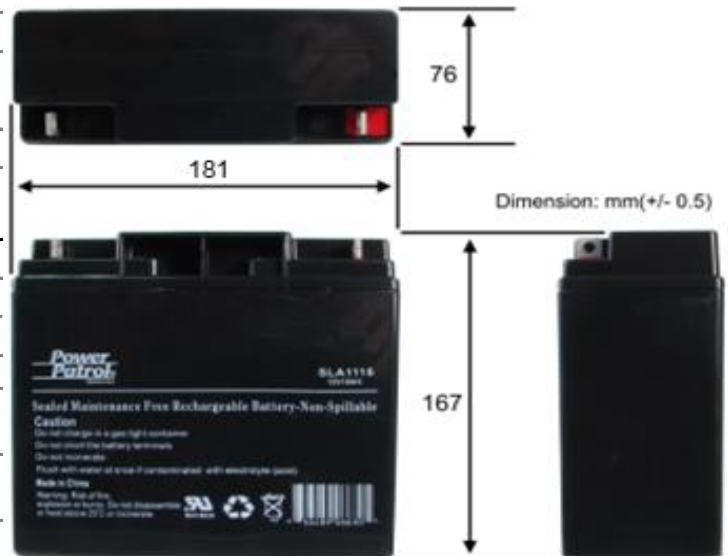

interstatebatteries.com

Power



BAZR2.MH



DISCHARGE CHARACTERISTIC CURVES AT 25°C (77°F)

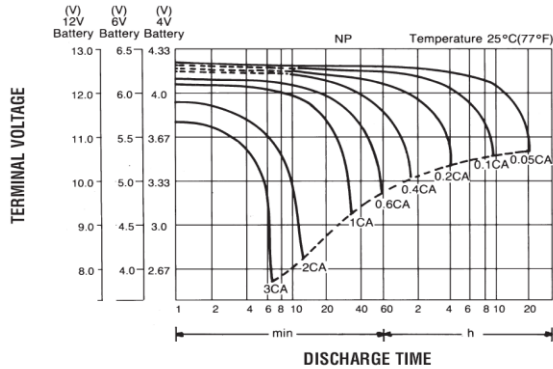

TEMPERATURE EFFECTS IN RELATION TO BATTERY CAPACITY

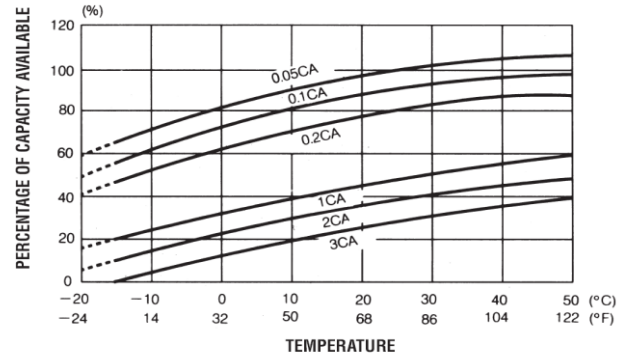

SELF DISCHARGE CHARACTERISTICS

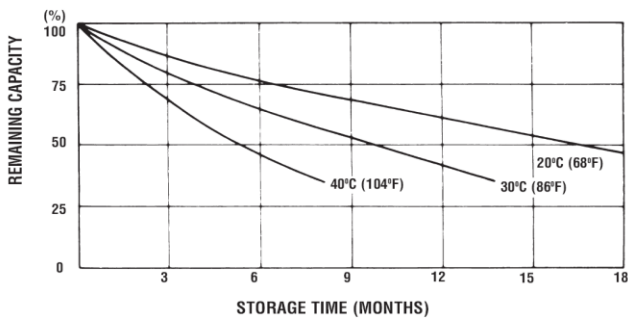

OPEN CIRCUIT VOLTAGE VS REMAINING CAPACITY

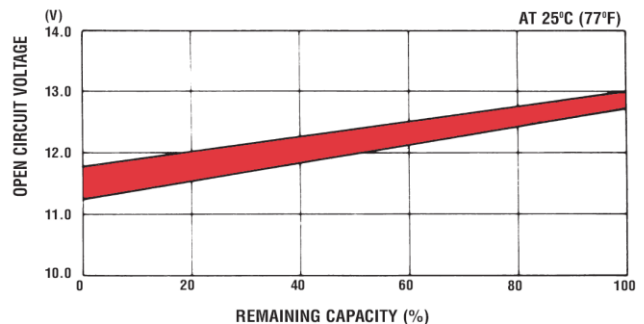

Actual Wattage/Ampere Capacity

(Volt per cell @ 77°F / 25°C)

		5 min	10 min	15 min	30 min	45 min	60 min
1.75 v/c	W	107.4	72.3	55.6	33.8	24.7	19.8
	A	61.4	41.3	31.8	19.3	14.1	11.3
1.67 v/c	W	104.8	72.2	55.3	33.5	25.1	20.0
	A	62.8	43.2	33.1	20.1	15.0	12.0
1.60 v/c	W	116.8	73.8	54.7	32.2	24.4	19.3
	A	73.0	46.1	34.2	20.1	15.2	12.1

FLOAT SERVICE LIFE

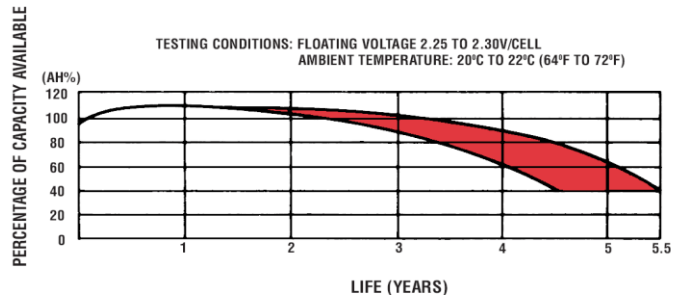

CAUTION: Do not charge in a sealed container. Avoid Short Circuit. Before using this battery in high current applications(>3C), consult with Interstate Batteries.

Notes: Leak-proof/spill-proof. Most SLA(Sealed Lead Acid) batteries now use AGM(Absorbent Glass Mat) technology which has largely replaced the old "gel" technology. In an AGM battery, fiberglass mats absorb the acid and hold it against the lead plates inside the battery. Because the acid is absorbed by the sponge-like mats, it will not leak or spill (provided proper charging and usage instructions are followed). Additional safety features include the use of special sealing epoxies, tongue-and-groove case and cover construction as well as long sealing paths for post and connectors. Our AGM batteries are approved for all modes of transport(water, road, rail, air, etc.).