

Bosch Seat drive for FRC donation (PN 6 004 RA3 194-06)



BOSCH

www.bosch.us

Note: Two locations are required for attachment 1) Fully supported pinion shaft 2) bolt hole. Do not use motor as shaft support

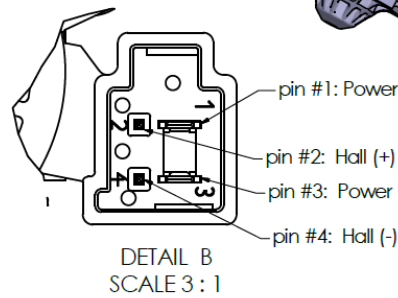
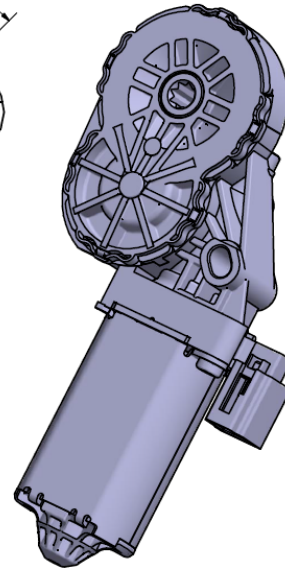
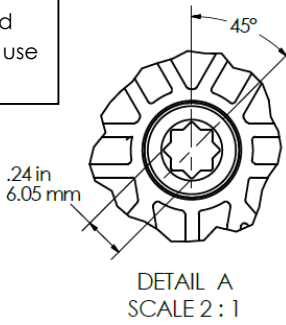
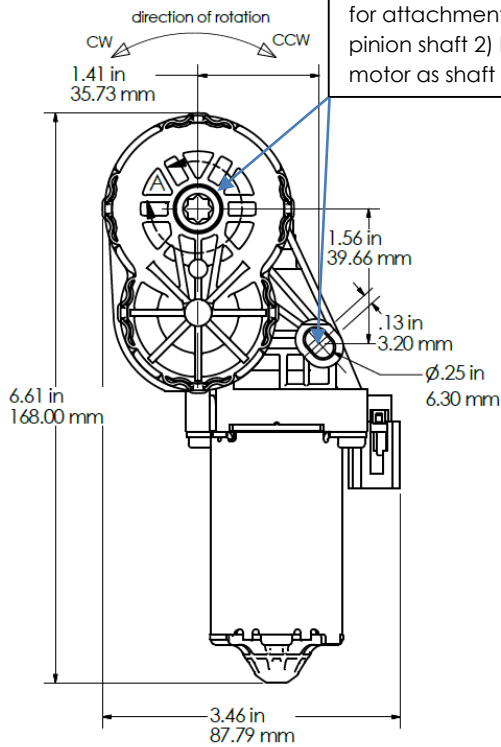

ROTATION DIRECTION		
pin	CW	CCW
#1	+	-
#3	-	+

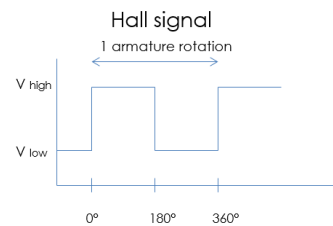
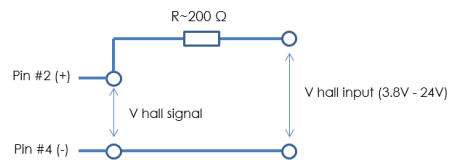
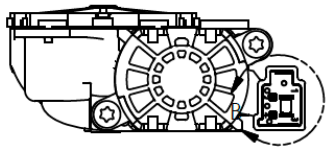

Note: 1 pinion rotation = 174.9 armature rotations

Performance values at 13V, 0Ω wire resistance

Bosch motor 6 004 RA3 194-06 Performance Curve

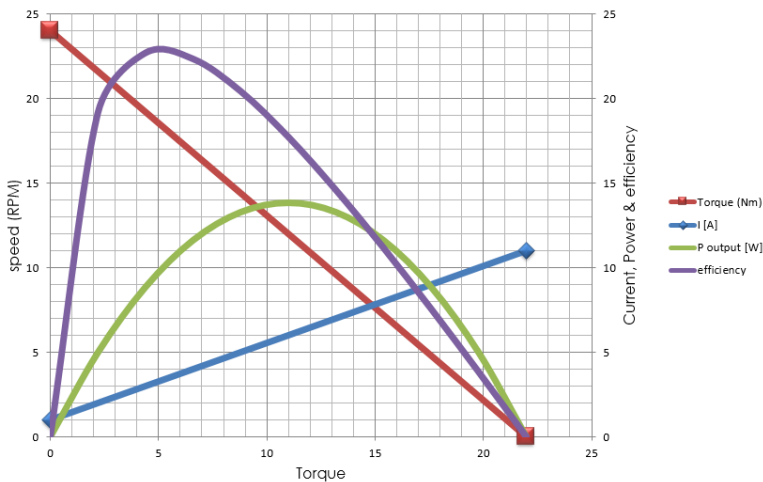

CRITERIA	VALUE (metric)	VALUE (SAE)
No load speed	24 RPM	
Stall Torque	22 Nm	16.2 ft-lbs
No load current	≤ 3 A	
Max stall current	12 A	
Weight	363 g	.8 lbs
Gear ratio in motor	174.9:1	